



SB160-18

Schottky Barrier Diode (Twin Type - Cathode Common)

180V, 16A Rectifier

Applications

- High frequency rectification (switching regulators, converters, choppers).

Features

- Low forward voltage (V_F max=0.85V).
- Fast reverse recovery time (t_{rr} max=60ns).
- Low switching noise.
- Low leakage current and high reliability due to highly reliable planar structure.

Package Dimensions

unit:mm

1160

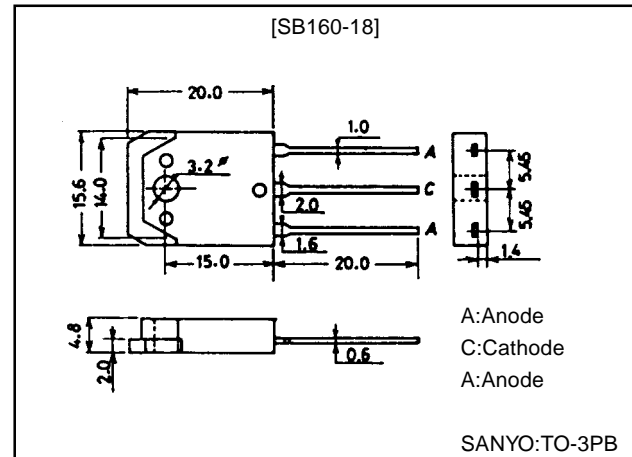

Specifications

Absolute Maximum Ratings at $T_a = 25^\circ\text{C}$

Parameter	Symbol	Conditions	Ratings	Unit
Repetitive Peak Reverse Voltage	V_{RRM}		-180	V
Nonrepetitive Peak Reverse Surge Voltage	V_{RSM}		-190	V
Average Output Current	I_O	50Hz, resistive load, $T_c=98^\circ\text{C}$	16	A
Surge Forward Current	I_{FSM}	50Hz sine wave, 1 cycle	140	A
Junction Temperature	T_j		-55 to +125	$^\circ\text{C}$
Storage Temperature	T_{stg}		-55 to +125	$^\circ\text{C}$

Electrical Characteristics

Parameter	Symbol	Conditions	Ratings			Unit
			min	typ	max	
Reverse Voltage	V_R	$I_R=-6\text{mA}$, $T_j=25^\circ\text{C}^*$	-180			V
Forward Voltage	V_F	$I_F=6\text{A}$, $T_j=25^\circ\text{C}^*$			0.85	V
Reverse Current	I_R	$V_R=-90\text{V}$, $T_j=25^\circ\text{C}^*$			-1.2	mA
Reverse Recovery Time	t_{rr}	$I_F=2\text{A}$, $T_j=25^\circ\text{C}^*$, $-dI_F/dt=10\text{A}/\mu\text{s}$			60	ns
Thermal Resistance	R_{thj-c}	Junction-Case:Smoothed DC			1.0	$^\circ\text{C}/\text{W}$

Note)*:Value per element

Electrical Connection

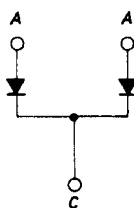

A:Anode
C:Cathode

SANYO Electric Co.,Ltd. Semiconductor Business Headquarters

TOKYO OFFICE Tokyo Bldg., 1-10, 1 Chome, Ueno, Taito-ku, TOKYO, 110-8534 JAPAN

SB160-18

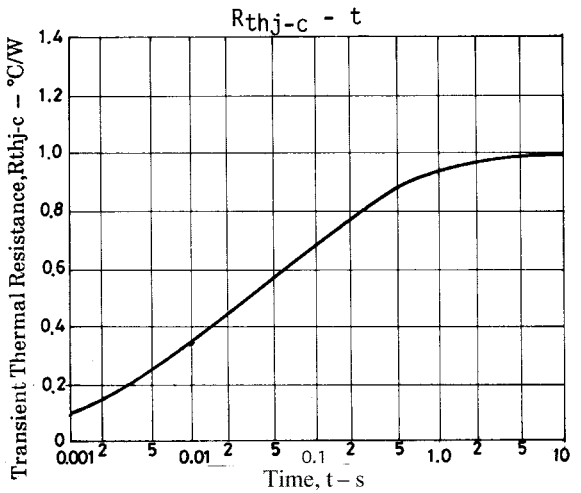
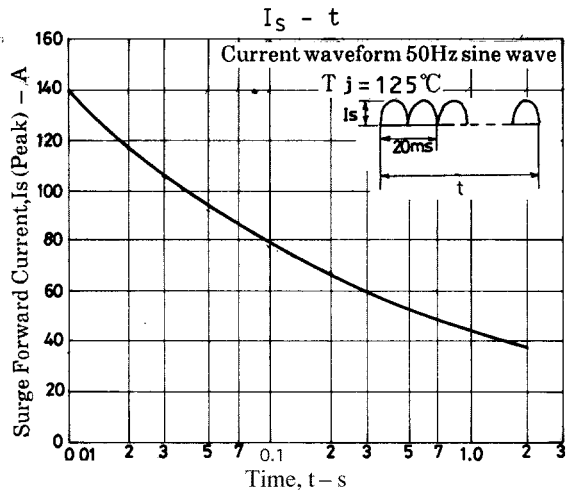
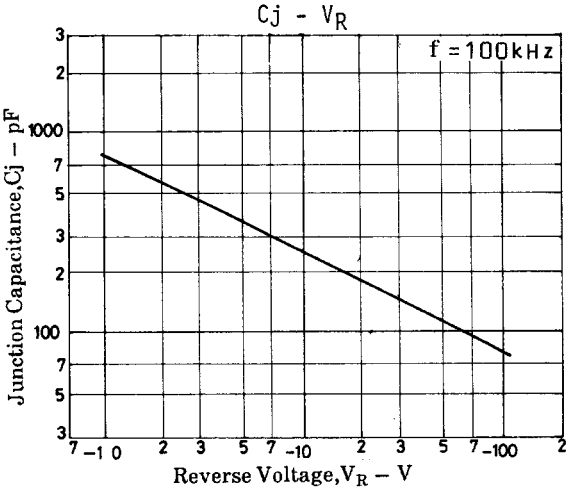
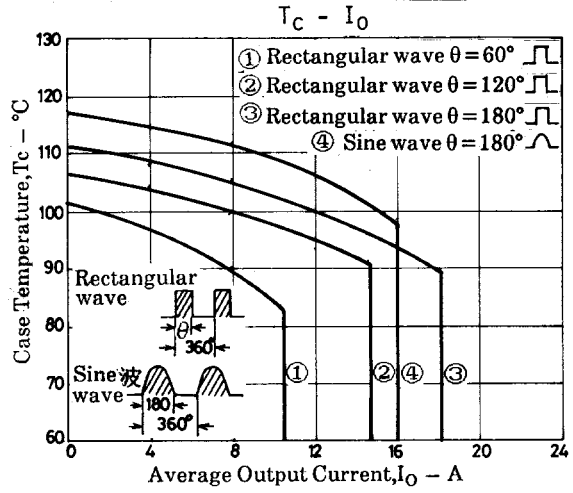
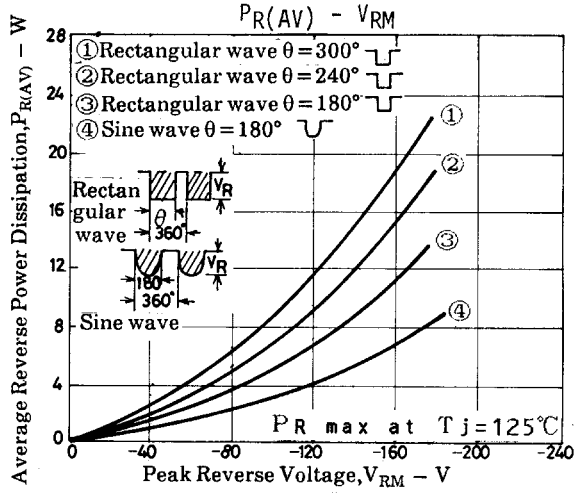
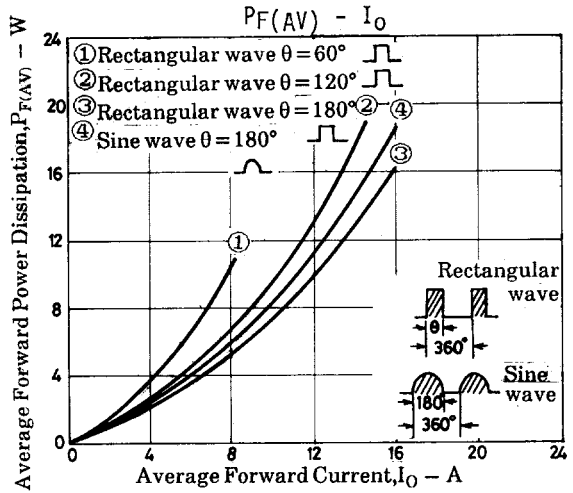
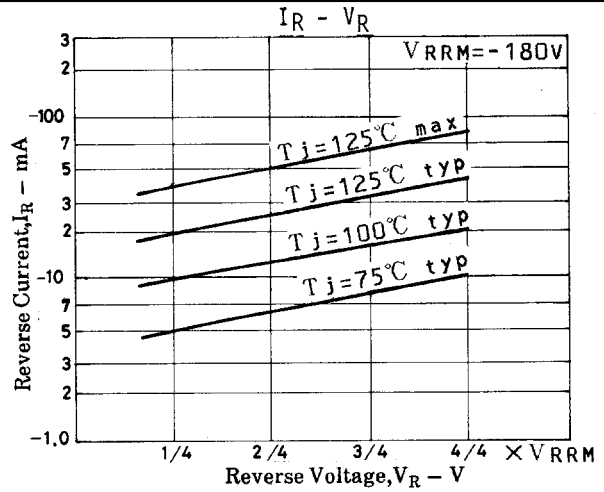
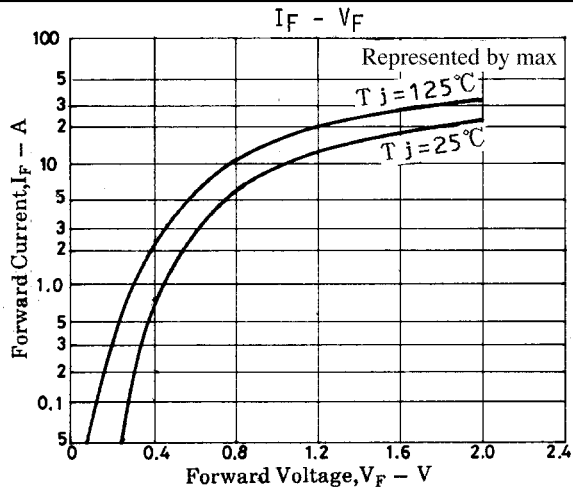

- No products described or contained herein are intended for use in surgical implants, life-support systems, aerospace equipment, nuclear power control systems, vehicles, disaster/crime-prevention equipment and the like, the failure of which may directly or indirectly cause injury, death or property loss.
- Anyone purchasing any products described or contained herein for an above-mentioned use shall:
 - ① Accept full responsibility and indemnify and defend SANYO ELECTRIC CO., LTD., its affiliates, subsidiaries and distributors and all their officers and employees, jointly and severally, against any and all claims and litigation and all damages, cost and expenses associated with such use:
 - ② Not impose any responsibility for any fault or negligence which may be cited in any such claim or litigation on SANYO ELECTRIC CO., LTD., its affiliates, subsidiaries and distributors or any of their officers and employees jointly or severally.
- Information (including circuit diagrams and circuit parameters) herein is for example only; it is not guaranteed for volume production. SANYO believes information herein is accurate and reliable, but no guarantees are made or implied regarding its use or any infringements of intellectual property rights or other rights of third parties.

This catalog provides information as of March, 1998. Specifications and information herein are subject to change without notice.